



HEAT PUMP INSTALLATION INSTRUCTIONS

Table of Contents

HEAT PUMP SAFETY PRECAUTIONS	1	ELECTRICAL CONNECTIONS	5
Important Note to the Owner Regarding Product Warranty	2	Over-current Protection	5
Shipping Inspection	2	High Voltage Connections	5
Codes and Regulations.....	2	Low Voltage Connections	5
Installation Clearances	2	SYSTEM START-UP	7
Rooftop Installations	2	FINAL CHARGE ADJUSTMENT	7
SAFE REFRIGERANT HANDLING	3	Fixed Orifice	8
REFRIGERANT LINES	3	Expansion Valve System.....	8
Burying Refrigerant Lines.....	4	2-Stage Application.....	9
Refrigerant Line Connections	4	Heat Pump—Heating Cycle	9
Leak Testing—Nitrogen or Nitrogen-Traced	4	TROUBLESHOOTING INFORMATION	10
System Evacuation	5	ASSISTANCE OR SERVICE	15



HEAT PUMP SAFETY PRECAUTIONS



The following symbols and labels are used throughout this manual to indicate immediate or potential safety hazards. It is the owner's and installer's responsibility to read and comply with all safety information and instructions accompanying these symbols. Failure to heed safety information increases the risk of personal injury, property damage, and/or product damage.

 Recognize this symbol as a safety precaution.

 WARNING
Hazards or unsafe practices <u>could</u> result in property damage, product damage, severe personal injury or death.
 CAUTION
Hazards or unsafe practices <u>may</u> result in property damage, product damage, personal injury or death.

CAUTION
Hazards or unsafe practices <u>may</u> result in property or product damage.

 WARNING
HIGH VOLTAGE!
Disconnect <u>ALL</u> power before servicing.
Multiple power sources may be present.

Failure to do so may cause property damage, personal injury or death.

 WARNING
Installation and repair of this unit should be performed ONLY by individuals meeting the requirements of an "Entry Level Technician," at a minimum, as specified by the Air-Conditioning, Heating and Refrigeration Institute (AHRI). Attempting to install or repair this unit without such background may result in product damage, personal injury or death.

CAUTION
Scroll equipped units should never be used to evacuate the air conditioning system. Vacuums this low can cause internal electrical arcing resulting in a damaged or failed compressor.



Important Note to the Owner Regarding Product Warranty

Your warranty certificate is supplied as a separate document with the unit installed by your contractor. Read the limited warranty certificate carefully to determine what is and is not covered. Keep the warranty certificate in a safe place. If you are unable to locate the warranty certificate, please contact your installing contractor, or contact customer service at 1-866-944-7575 to obtain a copy.

To receive the 10-Year Parts Limited Warranty, online registration must be completed within 60 days of installation. Online registration is not required in California or Quebec.

Product limited warranty certificates for models currently in production can be viewed at www.whirlpoolhvac.com. If your model is not currently in production or does not appear on the website, please contact your installing contractor or contact customer service at 1-866-944-7575 to obtain a copy of your warranty certificate.

To register your unit, go to www.whirlpoolhvac.com. Click on the manufacturer's Comfort Commitment™ Warranty link located at the bottom center of the home page. Next, click on the Click Here to Register Your Product link located at the top center of the page, and complete the forms in the manner indicated.

Shipping Inspection

Always keep the unit upright; laying the unit on its side or top may cause equipment damage. Shipping damage and subsequent investigation is the responsibility of the carrier. Verify the model number, specifications, electrical characteristics and accessories are correct prior to installation. The distributor or manufacturer will not accept claims from dealers for transportation damage or installation of incorrectly shipped units.

Codes and Regulations

This product is designed and manufactured to comply with national codes. Installation in accordance with such codes and/or prevailing local codes/regulations is the responsibility of the installer. The manufacturer assumes no responsibility for equipment installed in violation of any codes or regulations.

The United States Environmental Protection Agency (EPA) has issued various regulations regarding the introduction and disposal of refrigerants. Failure to follow these regulations may harm the environment and can lead to the imposition of substantial fines. Should you have any questions please contact the local office of the EPA.

If replacing a condensing unit or air handler, the system must be manufacturer-approved and Air Conditioning, Heating and Refrigeration Institute (AHRI) matched.

NOTE: Installation of unmatched systems is not allowed.

Operating the unit in a structure that is not complete (either as part of new construction or renovation) will void the warranty.

Installation Clearances

Special consideration must be given to the location of the heat pump(s) in regard to structures, obstructions, other units and any/all other factors that may interfere with air circulation. Where possible, the top of the unit should be completely unobstructed; however, if vertical conditions require placement beneath an obstruction, there should be a minimum of 60" (152 cm) between the top of the unit and the obstruction(s). The specified dimensions meet requirements for air circulation only. Consult all appropriate regulatory codes prior to determining final clearances.

Another important consideration in selecting a location for the unit(s) is the angle to obstructions. Either side adjacent the valves

can be placed toward the structure provided the side away from the structure maintains minimum service clearance.

NOTE: Corner installations are strongly discouraged.

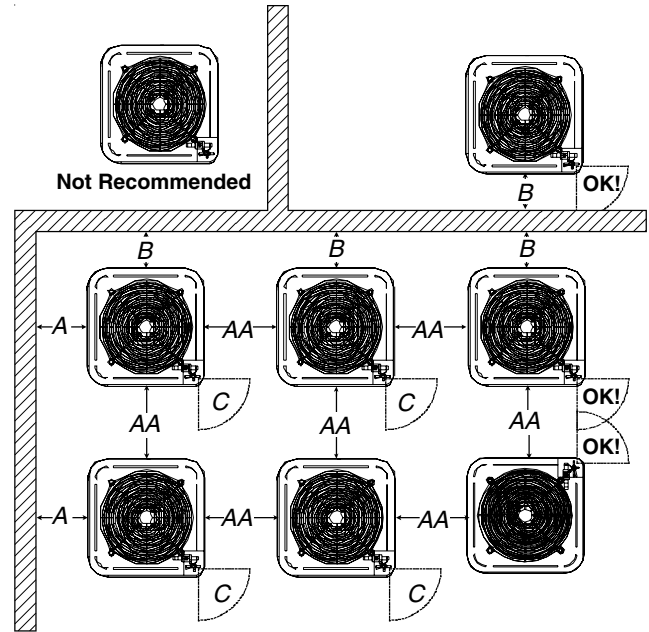

Minimum Airflow Clearance—in. (cm)

Model Type	A	B	C	AA
Residential	10 (25)	10 (25)	18 (46)	20 (51)
Light Commercial	12 (31)	12 (31)	18 (46)	24 (61)

This unit can be located at the ground floor level or on flat roofs. At ground floor level, the unit must be on a solid, level foundation that will not shift or settle. To reduce the possibility of sound transmission, the foundation slab should not be in contact with or be an integral part of the building foundation. Ensure the foundation is sufficient to support the unit. A concrete slab raised above ground level provides a suitable base.

Rooftop Installations

If it is necessary to install this unit on a roof structure, ensure the roof structure can support the weight and that proper consideration is given to the weather-tight integrity of the roof. Since the unit can vibrate during operation, sound vibration transmission should be considered when installing the unit. Vibration absorbing pads or springs can be installed between the unit legs or frame and the roof mounting assembly to reduce noise vibration.

NOTE: These units require special location consideration in areas of heavy snow accumulation and/or areas with prolonged continuous subfreezing temperatures. Heat pump unit bases have cutouts under the outdoor coil that permit drainage of frost accumulation. Situate the unit to permit free unobstructed drainage of the defrost water and ice. In more severe weather locations, it is recommended that the unit be elevated to allow unobstructed drainage and airflow.

The following elevation minimums are recommended:

Design Temperature	Suggested Minimum Elevation
+15°F (-9°C) and above	2½" (6.4 cm)
-5° (-20.6°C) to +14° (-10°C)	8" (20.3 cm)
below -5° (-20.6°C)	12" (30.5 cm)

SAFE REFRIGERANT HANDLING

While these items will not cover every conceivable situation, they should serve as a useful guide.

WARNING

To avoid possible injury, explosion or death, practice safe handling of refrigerants.

WARNING

Refrigerants are heavier than air. They can “push out” the oxygen in your lungs or in any enclosed space. To avoid possible difficulty in breathing or death:

- Never purge refrigerant into an enclosed room or space. By law, all refrigerants must be reclaimed.
- If an indoor leak is suspected, thoroughly ventilate the area before beginning work.
- Liquid refrigerant can be very cold. To avoid possible frostbite or blindness, avoid contact and wear gloves and goggles. If liquid refrigerant does contact your skin or eyes, seek medical help immediately.
- Always follow EPA regulations. Never burn refrigerant, as poisonous gas will be produced.

WARNING

To avoid possible explosion:

- Never apply flame or steam to a refrigerant cylinder. If you must heat a cylinder for faster charging, partially immerse it in warm water.
- Never fill a cylinder more than 80% full of liquid refrigerant.
- Never add anything other than R-22 to an R-22 cylinder or R-410A to an R-410A cylinder. The service equipment used must be listed or certified for the type of refrigerant used.
- Store cylinders in a cool, dry place. Never use a cylinder as a platform or a roller.

WARNING

To avoid possible explosion, use only returnable (not disposable) service cylinders when removing refrigerant from a system.

- Ensure the cylinder is free of damage which could lead to a leak or explosion.
- Ensure the hydrostatic test date does not exceed 5 years.
- Ensure the pressure rating meets or exceeds 400 lbs.

When in doubt, do not use cylinder.

REFRIGERANT LINES

CAUTION

The compressor POE oil for R-410A units is extremely susceptible to moisture absorption and could cause compressor failure. Do not leave system open to atmosphere any longer than necessary for installation.

Use only refrigerant-grade (dehydrated and sealed) copper tubing to connect the heat pump with the indoor evaporator. After cutting the tubing, install plugs to keep refrigerant tubing clean and dry prior to and during installation. Tubing should always be cut square, keeping the ends round and free from burrs. Clean the tubing to prevent contamination.

NOTE: Do not let the refrigerant lines come in direct contact with plumbing, ductwork, floor joists, wall studs, floors and walls. When running refrigerant lines through a foundation or wall, openings should allow for sound and vibration absorbing material to be placed or installed between tubing and foundation. Any gap between the foundation or wall and refrigerant lines should be filled with a pliable silicon-based caulk, RTV or a vibration damping material. Avoid suspending refrigerant tubing from joists and studs with rigid wire or straps that would come in contact with the tubing. Use an insulated or suspension-type hanger. Keep both lines separate and always insulate the suction line.

These sizes are recommended for line lengths of 79 ft (24 m) or less to obtain optimum performance. For alternate line sizing options or runs of more than 79 ft (24 m), refer to Remote Cooling Service Manual, TP-107 Long Line Set Application R- 410A or contact your distributor for assistance.

Recommended Interconnecting Tubing—ft (m)						
	0 to 24 (7)	25 to 49 (8 to 15)	50 to 79 (15 to 24)*			
Conditioner Line Diameter (in. OD)						
Unit Tons	Suction	Liquid	Suction	Liquid	Suction	Liquid
1½	5/8	¼	¾	¾	¾	¾
2	5/8	¼	¾	¾	¾	¾
2½	5/8	¼	¾	¾	7/8	¾
3	¾	¾	7/8	¾	1 1/8	¾
3½	7/8	¾	1 1/8	¾	1 1/8	¾
4	7/8	¾	1 1/8	¾	1 1/8	¾
5	7/8	¾	1 1/8	¾	1 1/8	¾

*For lines greater than 79 ft (24 m) in length or vertical elevation changes more than 50 ft (15 m), refer to the Remote Cooling Service Manual or contact your distributor for assistance.

Mounting the evaporator coil above the heat pump will require an inverted loop in the suction line adjacent or near the connection to the evaporator coil. The top of the loop must be slightly higher than the top of the evaporator coil.

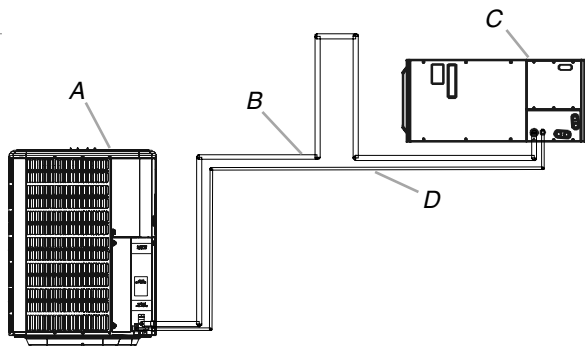

A. Heat pump
B. Suction line
C. Evaporator coil
D. Liquid line

Mounting the heat pump above the evaporator coil will require an oil trap in the suction line. Install one oil trap at the evaporator for a height difference of more than 15 ft (4.5 m) between indoor and outdoor units.

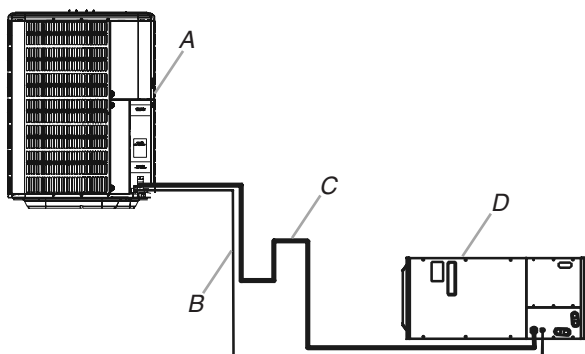

A. Heat pump
B. Liquid line
C. Suction line
D. Evaporator coil

Insulation is necessary to avoid condensation from forming and dropping from the suction line. Armaflex (or satisfactory equivalent) with $\frac{3}{8}$ " (1 cm) minimum wall thickness is recommended. In severe conditions (hot, high humidity areas), $\frac{1}{2}$ " (1.3 cm) insulation may be required. Insulation must be installed in a manner which keeps tubing from damage and contamination.

Where possible, drain as much residual compressor oil from existing systems, lines and traps; pay close attention to low areas where oil may collect.

NOTE: If changing refrigerant types, ensure the indoor coil and metering device is compatible with the type of refrigerant being used; otherwise, the indoor coil must be replaced.

Burying Refrigerant Lines

If burying refrigerant lines cannot be avoided, use the following checklist.

1. Insulate liquid and suction lines separately.
2. Enclose all underground portions of the refrigerant lines in waterproof material (conduit or pipe) sealing the ends where tubing enters/exits the enclosure.
3. If the lines must pass under or through a concrete slab, ensure lines are adequately protected and sealed.

Refrigerant Line Connections

IMPORTANT: To avoid overheating the service valve, TXV valve or filter dryer while brazing, wrap the component with a wet rag, or use a thermal heat trap compound. Be sure to follow the manufacturer's instruction when using the heat trap compound.

NOTE: Remove Schrader valves from service valves before brazing tubes to the valves. Use a brazing alloy of 2% minimum silver content. Do not use flux.

Torch heat required to braze tubes of various sizes is proportional to the size of the tube. Tubes of smaller size require less heat to bring the tube to brazing temperature before adding brazing alloy. Applying too much heat to any tube can melt the tube. Service personnel must use the appropriate heat level for the size of the tube being brazed.

NOTE: The use of a heat shield when brazing is recommended to avoid burning the serial plate or the finish on the unit.

1. The ends of the refrigerant lines must be cut square, deburred, cleaned and be round and free from nicks or dents. Any other condition increases the chance of a refrigerant leak.
2. "Sweep" the refrigerant line with nitrogen or inert gas during brazing to prevent the formation of copper-oxide inside the refrigerant lines. The POE oils used in R-410A applications will clean any copper-oxide present from the inside of the refrigerant lines and spread it throughout the system. This may cause a blockage or failure of the metering device.
3. After brazing, quench the joints with water or a wet cloth to prevent overheating of the service valve.
4. Ensure the filter dryer paint finish is intact after brazing. If the paint of the steel filter dryer has been burned or chipped, repaint or treat with a rust preventive. This is especially important on suction line filter dryers which are continually wet when the unit is operating.

NOTES:

- Be careful not to kink or dent refrigerant lines. Kinked or dented lines will cause poor performance or compressor damage.
- Do not make final refrigerant line connection until plugs are removed from refrigerant tubing.
- Before brazing, verify indoor piston size by checking the piston kit chart packaged with indoor unit.

Leak Testing—Nitrogen or Nitrogen-Traced

WARNING

To avoid the risk of fire or explosion, never use oxygen, high pressure air or flammable gases for leak testing of a refrigeration system.

WARNING

To avoid possible explosion, the line from the nitrogen cylinder must include a pressure regulator and a pressure relief valve. The pressure relief valve must be set to open at no more than 150 psig.

Pressure test the system using dry nitrogen and soapy water to locate leaks. If you wish to use a leak detector, charge the system to 10 psi using the appropriate refrigerant, and then use nitrogen to finish charging the system to working pressure. Apply the detector to suspect areas. If leaks are found, repair them. After repair, repeat the pressure test. If no leaks exist, proceed to system evacuation.

System Evacuation

Condensing unit liquid and suction valves are closed to contain the charge within the unit. The unit is shipped with the valve stems closed and caps installed.

NOTE: Do not open valves until the system is evacuated.

WARNING

REFRIGERANT UNDER PRESSURE!

Failure to follow proper procedures may cause property damage, personal injury or death.

NOTE: Scroll compressors should never be used to evacuate or pump down a heat pump or air conditioning system.

CAUTION

Prolonged operation at suction pressures less than 20 psig for more than 5 seconds will result in overheating of the scrolls and permanent damage to the scroll tips, drive bearings and internal seal.

1. Connect the vacuum pump with 250 micron capability to the service valves.
2. Evacuate the system to 250 microns or less using suction and liquid service valves. Using both valves is necessary as some compressors create a mechanical seal separating the sides of the system.

3. Close pump valve and hold vacuum for 10 minutes. Typically pressure will rise during this period.

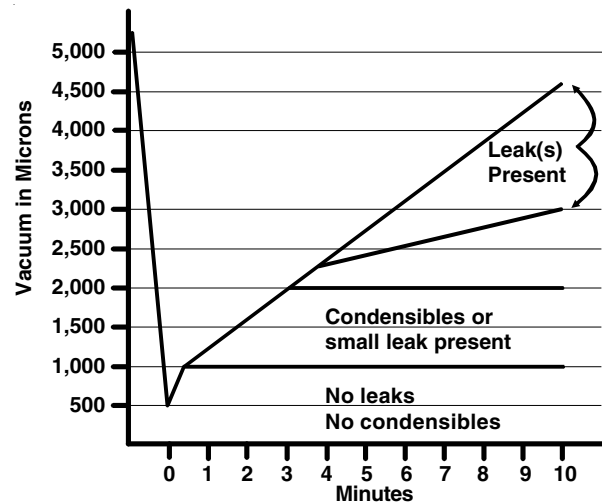

- If the pressure rises to 1,000 microns or less and remains steady, the system is considered leak-free; proceed to start-up.
- If pressure rises above 1,000 microns but holds steady below 2,000 microns, moisture and/or noncondensibles may be present or the system may have a small leak. Return to Step 2: If the same result is encountered, check for leaks as previously indicated and repair as necessary, and then repeat evacuation.
- If pressure rises above 2,000 microns, a leak is present. Check for leaks as previously indicated and repair as necessary, and then repeat evacuation.

ELECTRICAL CONNECTIONS

WARNING

HIGH VOLTAGE!

Disconnect ALL power before servicing.
Multiple power sources may be present.
Failure to do so may cause property damage, personal injury or death due to electric shock.
Wiring must conform with NEC or CEC and all local codes. Undersized wires could cause poor equipment performance, equipment damage or fire.



WARNING

To avoid the risk of fire or equipment damage, use copper conductors.

NOTICE

Units with reciprocating compressors and non-bleed TXV's require a Hard Start Kit.

The unit rating plate lists pertinent electrical data necessary for proper electrical service and over-current protection. Wires should be sized to limit voltage drop to 2% (maximum) from the main breaker or fuse panel to the unit.

Consult the NEC, CEC and all local codes to determine the correct wire gauge and length.

Local codes often require a disconnect switch located near the unit; do not install the switch on the unit. Refer to the installation instructions supplied with the indoor furnace/air handler for specific wiring connections and indoor unit configuration. Likewise, consult the instructions packaged with the thermostat for mounting and location information.

Over-current Protection

The following over-current protection devices are approved for use.

- Time-delay fuses
- HACR-type circuit breakers

These devices have sufficient time delay to permit the motor compressor to start and accelerate its load.

High Voltage Connections

Route power supply and ground wires through the high-voltage port and terminate in accordance with the wiring diagram provided inside the control panel cover.

Low Voltage Connections

Heat pump control wiring requires 24-Volt minimum, 25VA service from the indoor transformer. Low voltage wiring for 2-stage units depends on the thermostat used and the number of control wires between the indoor unit and the heat pump. Route the control wires through the low voltage port and terminate in accordance with the wiring diagram provided inside the control panel cover.

System Composite Diagram—Heat Pumps 10 KW and Below

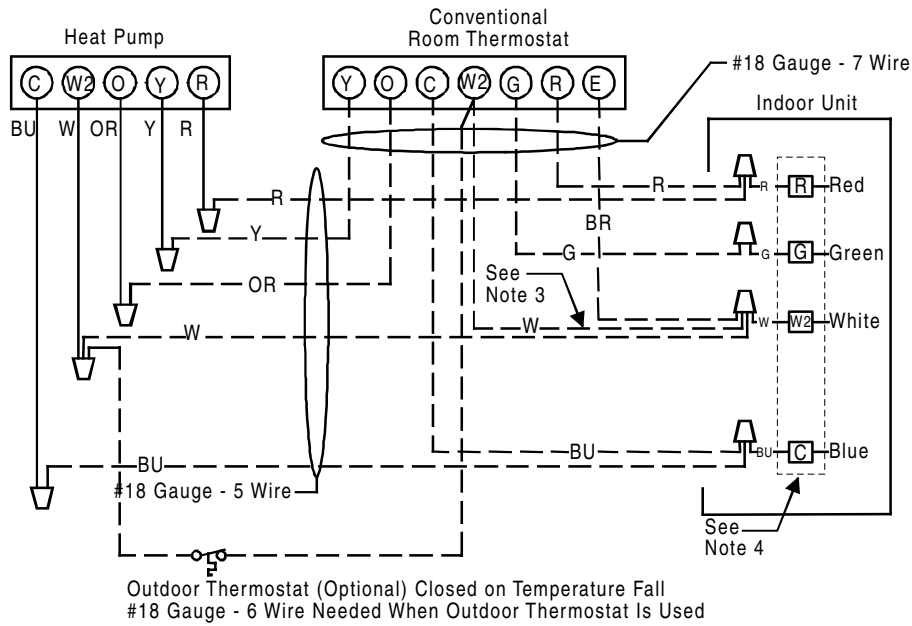

System Composite Diagram—Heat Pumps Above 10 KW

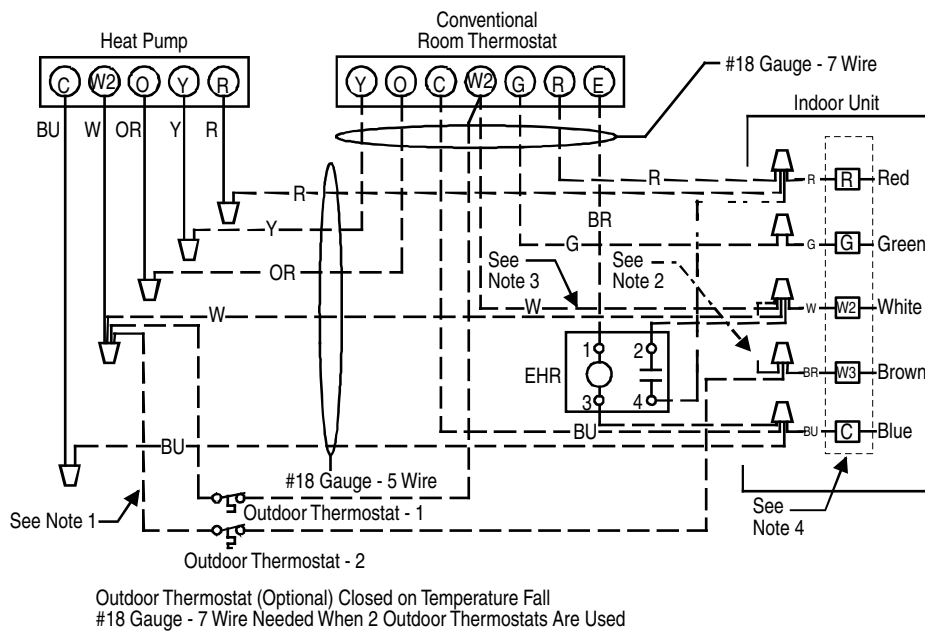

NOTES:

- EHR—Emergency Heat Relay (optional)
- 1. Outdoor thermostat (OT-1) should be the first to close and the last to open.
- 2. Connect white wires and brown wires from air handler together if OT-2 is not used.
- 3. Remove wire when using outdoor thermostat.
- 4. Terminal block markings.

NOTE: For 2-stage units, refer to the Installation Instructions supplied with the variable-speed indoor units for field wiring connections.

Symbol	Color	Symbol	Color
R	Red	Y	Yellow
BU	Blue	G	Green
BR	Brown	W	White
OR	Orange		

SYSTEM START-UP

- Power must be supplied to the 18 SEER outdoor units containing ECM motors before the power is applied to the indoor unit. Sending a low-voltage signal without high-voltage power present at the outdoor unit can cause a malfunction of the control module on the ECM motor.
- Adequate refrigerant charge for a matching evaporator and 15 ft (4.6 m) lineset is supplied with the condensing unit. If line set exceeds 15 ft (4.6 m) in length, refrigerant should be added at 0.6 oz per foot of liquid line.

IMPORTANT: Open the suction service valve first. If the liquid service valve is opened first, oil from the compressor may be drawn into the indoor coil TXV, restricting refrigerant flow and affecting operation of the system.

 **CAUTION**

POSSIBLE REFRIGERANT LEAK

To avoid a possible refrigerant leak, open the service valves until the top of the stem is $\frac{1}{8}$ " (3.2 mm) from the retainer.

When opening valves with retainers, open each valve only until the top of the stem is $\frac{1}{8}$ " (3.2 mm) from the retainer.

NOTE: To avoid loss of refrigerant, do not apply pressure to the retainer.

When opening valves without a retainer, remove the service valve cap, and insert a hex wrench into the valve stem. Back out the stem by turning the hex wrench counterclockwise. Open the valve until it contacts the rolled lip of the valve body.

NOTE: These are not back-seating valves. It is not necessary to force the stem tightly against the rolled lip.

After the refrigerant charge has bled into the system, open the liquid service valve. The service valve cap is the secondary seal for the valves and must be properly tightened to prevent leaks. Make sure the cap is clean and apply refrigerant oil to the threads and sealing surface on the inside of the cap. Tighten the cap finger tight, and then tighten an additional $\frac{1}{8}$ of a turn (1 wrench flat), or to the following specification, to properly seat the sealing surfaces.

- $\frac{3}{8}$ " valve to 5 to 10 in.-lbs
- $\frac{3}{4}$ " valve to 5 to 20 in.-lbs
- $\frac{5}{8}$ " valve to 5 to 20 in.-lbs
- $\frac{7}{8}$ " valve to 5 to 20 in.-lbs

NOTE: Do not introduce liquid refrigerant from the cylinder into the crankcase of the compressor as this may damage the compressor.

 **CAUTION**

POSSIBLE REFRIGERANT LEAK

To avoid a possible refrigerant leak, open the service valves until the top of the stem is $\frac{1}{8}$ " (3.2 mm) from the retainer.

1. Break the vacuum by fully opening liquid and suction base valves.
2. Set thermostat to call for cooling.
3. Check indoor and outdoor fan operation and allow system to stabilize for 10 minutes for fixed orifices and 20 minutes for expansion valves.

FINAL CHARGE ADJUSTMENT

The outdoor temperature must be 60°F (16°C) or higher. Set the room thermostat to COOL, the fan switch to AUTO and set the temperature control well below room temperature.

After the system has stabilized according to the start-up instructions, check the subcooling and superheat as detailed in the following section.

 **WARNING**

REFRIGERANT UNDER PRESSURE!

- Do not overcharge system with refrigerant.
- Do not operate unit in a vacuum or at negative pressure.

Failure to follow proper procedures may cause property damage, personal injury or death.

CAUTION

Use refrigerant certified to AHRI standards. Used refrigerant may cause compressor damage, and will void the warranty. Most portable machines cannot clean used refrigerant to meet AHRI standards.

NOTICE

Violation of EPA regulations may result in fines or other penalties.

CAUTION

Operating the compressor with the suction valve closed will void the warranty and cause serious compressor damage.

System Superheat

Outdoor Dry Bulb Temperature °F	Indoor Wet Bulb Temperature °F								
	55	57	59	61	63	65	67	69	71
60	10	13	17	20	23	26	29	30	31
65	8	11	14	16	19	22	26	27	29
70	5	8	10	13	15	19	23	24	25
75	---	4	6	9	11	15	20	21	23
80	---	---	1	4	7	12	17	18	20
85	---	---	---	---	3	8	13	15	16
90	---	---	---	---	---	5	10	11	13
95	---	---	---	---	---	1	5	8	10
100	---	---	---	---	---	---	3	5	8
105	---	---	---	---	---	---	---	3	5
110	---	---	---	---	---	---	---	---	3
115	---	---	---	---	---	---	---	---	2

Fixed Orifice



WARNING

To prevent personal injury, carefully connect and disconnect manifold gauge hoses. Escaping liquid refrigerant can cause burns. Do not vent refrigerant into the atmosphere. Recover all refrigerant during system repair and before final unit disposal.

1. Purge the gauge lines.
2. Connect the service gauge manifold to the base-valve service ports. Run system at least 10 minutes to allow pressure to stabilize.
3. Temporarily install the thermometer on the suction (large) line near the compressor. The thermometer should be located within 4" (10.2 cm) to 6" (15.2 cm) of the compressor. Ensure that the thermometer makes adequate contact and is insulated.

NOTE: An optional, less accurate, method is to locate the thermometer at the suction line service valve. Ensure that the thermometer makes adequate contact and is insulated.

4. Refer to the superheat chart provided for proper system superheat. Add charge to lower superheat or recover charge to raise superheat.

5. Disconnect the manifold set; installation is complete.
Superheat = Suction Line Temperature - Saturated Suction Temperature.

Expansion Valve System

Single Speed Application

1. Purge gauge lines.
2. Connect the service gauge manifold to the base-valve service ports. Run the system at least 10 minutes to allow pressure to stabilize.
3. Temporarily install the thermometer on the liquid (small) line near the liquid line service valve with adequate contact and insulate for best possible reading.
4. Check subcooling and superheat. Systems with TXV application should have a subcooling of 7°F ± 2°F and superheat of 7°F to 9°F.
 - If the subcooling and superheat are low, adjust TXV to 7°F to 9°F superheat. Check subcooling.

NOTE: To adjust the superheat, turn the valve stem clockwise to increase and counterclockwise to decrease.
 - If the subcooling is low and the superheat is high, add charge to raise the subcooling to 7°F ± 2°F. Check superheat.
 - If subcooling and superheat are high, adjust TXV valve to 7°F to 9°F superheat. Check subcooling.
 - If subcooling is high and superheat is low, adjust TXV valve to 7°F to 9°F superheat and remove charge to lower the subcooling to 7°F ± 2°F.

NOTE: Do not adjust the charge based on the suction pressure unless there is a gross undercharge.
5. Disconnect the manifold set. Installation is now complete.
Subcooling = Saturated Liquid Temperature - Liquid Line Temperature.

2-Stage Application

Run the condensing unit on low-stage cooling for 10 minutes until refrigerant pressures stabilize. Follow the guidelines and methods below to check the unit operation and ensure that the refrigerant charge is within limits. Charge the unit on low stage.

1. Purge the gauge lines.
2. Connect the service gauge manifold to the base-valve service ports.
3. Run the system at least 10 minutes to allow the pressure to stabilize.
4. Temporarily install a thermometer on the liquid (small) line near the liquid line service valve with adequate contact. Insulate the thermometer for the best possible reading.
5. Check the subcooling and superheat. Systems with TXV application should have a subcooling of 5°F to 7°F and superheat of 7°F to 9°F.
 - If the subcooling and superheat are low, adjust TXV to 7°F to 9°F superheat. Check subcooling.

NOTE: To adjust the superheat, turn the valve stem clockwise to increase and counterclockwise to decrease.

- If the subcooling is low and the superheat is high, add charge to raise the subcooling to 5°F to 7°F. Check superheat.
- If subcooling and superheat are high, adjust TXV valve to 7°F to 9°F superheat. Check subcooling.
- If subcooling is high and superheat is low, adjust TXV valve to 7°F to 9°F superheat and remove charge to lower the subcooling to 5°F to 7°F.

NOTE: Do not adjust the charge based on the suction pressure unless there is a gross undercharge.

6. Disconnect manifold set, installation is complete.

Subcooling = Saturated Liquid Temperature - Liquid Line Temperature

NOTE: Check the Schrader ports for leaks and tighten valve cores if necessary. Install caps finger tight.

Heat Pump—Heating Cycle

The proper method of charging a heat pump in the heat mode is by weight with the additional charge adjustments for line size, line length and other system components. Make final charge adjustments in the cooling cycle.

Saturated Suction Pressure Temperature

Suction Pressure	Saturated Suction Temperature °F	Suction Pressure	Saturated Suction Temperature °F
PSIG	R-410A	PSIG	R-410A
50	1	78	20
52	3	80	21
54	4	85	24
56	6	90	26
58	7	95	29
60	8	100	31
62	10	110	36
64	11	120	41
66	13	130	45
68	14	140	49
70	15	150	53
72	16	160	56
74	17	170	60
76	19		

NOTE: Subcooling = Saturated Liquid Temperature - Liquid Line Temperature

Saturated Liquid Pressure Temperature

Liquid Pressure	Saturated Liquid Temperature °F	Liquid Pressure	Saturated Liquid Temperature °F
PSIG	R-410A	PSIG	R-410A
200	70	375	112
210	73	405	118
220	76	415	119
225	78	425	121
235	80	435	123
245	83	445	125
255	85	475	130
265	88	500	134
275	90	525	138
285	92	550	142
295	95	575	145
305	97	600	149
325	101	625	152
355	108		

TROUBLESHOOTING INFORMATION

Problem

No Cooling/Heating

Cause/Test Method and/or Solution

- | | |
|--|--|
| <ul style="list-style-type: none"> ■ System will not start. | <ul style="list-style-type: none"> ■ Power failure. Test voltage. ■ Blown fuse. Inspect fuse size and type. Replace, if needed. ■ Loose connection. Inspect connection. Tighten if needed. ■ Shorted or broken wires. Test circuits with ohmmeter. Replace if needed. ■ Faulty thermostat. Test continuity of thermostat and wiring. Replace, if needed. ■ Faulty transformer. Check control circuit with voltmeter. Replace, if needed. |
| <ul style="list-style-type: none"> ■ Compressor will not start—fan runs. | <ul style="list-style-type: none"> ■ Shorted or broken wires. Test circuits with ohmmeter. Replace if needed. ■ Shorted or open capacitor. Test capacitor. ■ Internal compressor overload open. Test continuity of overload. ■ Shorted or grounded compressor. Test motor windings. ■ Compressor stuck. Use test cord. ■ Low voltage. Test voltage. |
| <ul style="list-style-type: none"> ■ Compressor and condenser fan will not start. | <ul style="list-style-type: none"> ■ Blown fuse. Inspect fuse size and type. Replace, if needed. ■ Shorted or broken wires. Test circuits with ohmmeter. Replace if needed. ■ Faulty thermostat. Test continuity of thermostat and wiring. Replace, if needed. ■ Faulty transformer. Check control circuit with voltmeter. Replace, if needed. ■ Faulty compressor contactor. Test continuity of coil and contacts. Replace, if needed. |

Problem

No Cooling/Heating**Cause/Test Method and/or Solution**

- | | |
|---|---|
| <ul style="list-style-type: none">■ Evaporator fan will not start. | <ul style="list-style-type: none">■ Blown fuse. Inspect fuse size and type. Replace, if needed.■ Loose connection. Inspect connection. Tighten if needed.■ Shorted or broken wires. Test circuits with ohmmeter. Replace if needed.■ Open fan overload. Test continuity of overloads.■ Faulty thermostat. Test continuity of thermostat and wiring. Replace, if needed.■ Shorted or open capacitor. Test capacitor.■ Faulty fan relay. Test continuity of coil and contacts.■ Open control circuit. Test control circuit with voltmeter.■ Faulty evaporator fan motor. Repair or replace. |
| <ul style="list-style-type: none">■ Condenser fan will not start. | <ul style="list-style-type: none">■ Shorted or broken wires. Test circuits with ohmmeter. Replace if needed.■ Open fan overload. Test continuity of overloads.■ Shorted or open capacitor. Test capacitor.■ Faulty compressor contactor. Test continuity of coil and contacts. Replace, if needed.■ Shorted or grounded fan motor. Test motor windings.■ Faulty defrost control. Test control. |
| <ul style="list-style-type: none">■ Compressor runs—goes off on overload. | <ul style="list-style-type: none">■ Loose connection. Inspect connection. Tighten if needed.■ Shorted or broken wires. Test circuits with ohmmeter. Replace if needed.■ Shorted or open capacitor. Test capacitor.■ Shorted or grounded compressor. Test motor windings.■ Compressor stuck. Use test cord.■ Faulty compressor contactor. Test continuity of coil and contacts. Replace, if needed.■ Low voltage. Test voltage.■ Overcharge of refrigerant. Recover part of charge.■ Dirty outdoor coil. Inspect coil and clean, if needed.■ Improperly located thermostat. Relocate thermostat.■ Wrong type of expansion valve. Replace valve.■ Expansion valve restricted. Remove restriction or replace valve.■ Undersized expansion valve. Replace valve.■ Inoperative expansion valve. Check valve operation. Replace if needed.■ Faulty reversing valve. Replace valve or solenoid. |
| <ul style="list-style-type: none">■ Compressor cycles on overload. | <ul style="list-style-type: none">■ Shorted or open capacitor. Test capacitor.■ Compressor stuck. Use test cord.■ Low voltage. Test voltage.■ Improper cooling anticipator. Check resistance of anticipator.■ Shortage of refrigerant. Test for leaks. Add refrigerant.■ Restricted liquid line. Replace restricted part.■ Overcharge of refrigerant. Recover part of charge.■ Dirty outdoor coil. Inspect coil and clean, if needed.■ Noncondensibles. Recover charge. Evacuate and recharge.■ Recirculation of condensing air. Remove obstruction to airflow.■ Wrong type of expansion valve. Replace valve.■ Expansion valve restricted. Remove restriction or replace valve.■ Undersized expansion valve. Replace valve. |

Problem

No Cooling/Heating**Cause/Test Method and/or Solution**

- | | |
|--|--|
| <ul style="list-style-type: none">■ System runs continuously—little cooling/heating. | <ul style="list-style-type: none">■ Shortage of refrigerant. Test for leaks. Add refrigerant.■ Restricted liquid line. Replace restricted part.■ Open element or limit on electric heater (heating only). Test heater element and controls.■ Dirty air filter. Inspect filter; clean or replace as needed.■ Dirty indoor coil. Inspect coil and clean, if needed.■ Not enough air across indoor coil. Check blower speed. Check duct static pressure and filter.■ Infiltration of outdoor air. Check windows, doors, vent fans, etc.■ System undersized. Refigure cooling load.■ Broken valves. Test compressor efficiency.■ Inefficient compressor. Test compressor efficiency.■ Wrong type of expansion valve. Replace valve.■ Expansion valve restricted. Remove restriction or replace valve.■ Oversized expansion valve. Replace valve.■ Undersized expansion valve. Replace valve.■ Inoperative expansion valve. Check valve operation. Replace if needed.■ Flowrator not seating properly. Check flowrator and seat, or replace flowrator. |
| <ul style="list-style-type: none">■ Too cool/warm and then too warm/cool. | <ul style="list-style-type: none">■ Faulty thermostat. Test continuity of thermostat and wiring. Replace, if needed.■ Improper cooling anticipator. Check resistance of anticipator.■ Improperly located thermostat. Relocate thermostat.■ Airflow unbalanced. Readjust air volume dampers. |
| <ul style="list-style-type: none">■ Not cool enough on warm days. | <ul style="list-style-type: none">■ Dirty air filter. Inspect filter; clean or replace as needed.■ Dirty indoor coil. Inspect coil and clean, if needed.■ Not enough air across indoor coil. Check blower speed. Check duct static pressure and filter.■ Noncondensibles. Recover charge. Evacuate and recharge.■ Recirculation of condensing air. Remove obstruction to airflow.■ Infiltration of outdoor air. Check windows, doors, vent fans, etc.■ System undersized. Refigure cooling load.■ Wrong type of expansion valve. Replace valve.■ Expansion valve restricted. Remove restriction or replace valve.■ Undersized expansion valve. Replace valve. |
| <ul style="list-style-type: none">■ Certain areas too cool, others too warm. | <ul style="list-style-type: none">■ Dirty air filter. Inspect filter; clean or replace as needed.■ Dirty indoor coil. Inspect coil and clean, if needed.■ Not enough air across indoor coil. Check blower speed. Check duct static pressure and filter.■ Infiltration of outdoor air. Check windows, doors, vent fans, etc.■ Airflow unbalanced. Readjust air volume dampers. |

Problem

No Cooling/Heating**Cause/Test Method and/or Solution**

Unsatisfactory Cooling/Heating

- | | |
|---|---|
| <ul style="list-style-type: none">■ Compressor is noisy. | <ul style="list-style-type: none">■ Overcharge of refrigerant. Recover part of charge.■ Broken internal parts. Replace compressor.■ Broken valves. Test compressor efficiency. Replace if needed.■ Expansion valve bulb loose. Tighten bulb bracket.■ Loose hold-down bolts. Tighten bolts. |
| <ul style="list-style-type: none">■ Heating Only—System runs—blows cold air in heating. | <ul style="list-style-type: none">■ Internal compressor overload open. Test continuity of overload.■ Compressor stuck. Use test cord.■ Shortage of refrigerant. Test for leaks. Add refrigerant.■ Open element or limit on electric heater (heating only). Test heater element and controls.■ Overcharge of refrigerant. Recover part of charge.■ Noncondensibles. Recover charge. Evacuate and recharge.■ Broken internal parts. Replace compressor.■ Inefficient compressor. Test compressor efficiency.■ Faulty reversing valve. Replace valve or solenoid.■ Faulty defrost control. Test control.■ Faulty defrost thermostat. Test defrost thermostat. |
| <ul style="list-style-type: none">■ Heating Only—Unit will not terminate defrost. | <ul style="list-style-type: none">■ Faulty reversing valve. Replace valve or solenoid.■ Faulty defrost control. Test control.■ Faulty defrost thermostat. Test defrost thermostat. |
| <ul style="list-style-type: none">■ Heating Only—Unit will not defrost. | <ul style="list-style-type: none">■ Faulty reversing valve. Replace valve or solenoid.■ Faulty defrost control. Test control.■ Faulty defrost thermostat. Test defrost thermostat. |
-

System Operating Pressures

- | | |
|---|--|
| <ul style="list-style-type: none">■ Low suction pressure. | <ul style="list-style-type: none">■ Faulty evaporator fan motor. Repair or replace.■ Shortage of refrigerant. Test for leaks. Add refrigerant.■ Restricted liquid line. Replace restricted part.■ Dirty air filter. Inspect filter; clean or replace as needed.■ Dirty indoor coil. Inspect coil and clean, if needed.■ Not enough air across indoor coil. Check blower speed. Check duct static pressure and filter.■ Dirty outdoor coil (heating only). Inspect coil and clean, if needed.■ Wrong type of expansion valve. Replace valve.■ Expansion valve restricted. Remove restriction or replace valve.■ Undersized expansion valve. Replace valve.■ Inoperative expansion valve. Check valve operation. Replace if needed.■ Faulty defrost control (heating only). Test control.■ Faulty defrost thermostat (heating only). Test defrost thermostat. |
| <ul style="list-style-type: none">■ Low head pressure. | <ul style="list-style-type: none">■ Shortage of refrigerant. Test for leaks. Add refrigerant.■ Restricted liquid line. Replace restricted part.■ Too much air across indoor coil (heating only). Reduce blower speed.■ Broken valves. Test compressor efficiency. Replace if needed.■ Inefficient compressor. Test compressor efficiency.■ Wrong type of expansion valve. Replace valve.■ Expansion valve restricted. Remove restriction or replace valve.■ Faulty reversing valve (heating only). Replace valve or solenoid.■ Faulty defrost control (heating only). Test control.■ Faulty defrost thermostat (heating only). Test defrost thermostat.■ Flowrator not seating properly. Check flowrator and seat, or replace flowrator. |

Problem

No Cooling/Heating**Cause/Test Method and/or Solution**

- | | |
|--|--|
| <ul style="list-style-type: none">■ High suction pressure. | <ul style="list-style-type: none">■ Too much air across indoor coil. Reduce blower speed.■ Overcharge of refrigerant. Recover part of charge.■ Broken valves. Test compressor efficiency. Replace if needed.■ Inefficient compressor. Test compressor efficiency.■ Expansion valve bulb loose. Tighten bulb bracket.■ Faulty reversing valve (heating only). Replace valve or solenoid.■ Faulty defrost thermostat (heating only). Test defrost thermostat.■ Flowrator not seating properly. Check flowrator and seat, or replace flowrator. |
| <ul style="list-style-type: none">■ High head pressure. | <ul style="list-style-type: none">■ Faulty evaporator fan motor (heating only). Repair or replace.■ Shorted or grounded fan motor. Test motor windings.■ Restricted liquid line. Replace restricted part.■ Dirty air filter (heating only). Inspect filter; clean or replace as needed.■ Dirty indoor coil (heating only). Inspect coil and clean, if needed.■ Not enough air across indoor coil (heating only). Check blower speed. Check duct static pressure and filter.■ Overcharge of refrigerant. Recover part of charge.■ Dirty outdoor coil. Inspect coil and clean, if needed.■ Noncondensibles. Recover charge. Evacuate and recharge.■ Recirculation of condensing air. Remove obstruction to airflow.■ Wrong type of expansion valve (heating only). Replace valve.■ Expansion valve restricted. Remove restriction or replace valve.■ Oversized expansion valve. Replace valve.■ Faulty reversing valve (heating only). Replace valve or solenoid.■ Faulty defrost control (heating only). Test control.■ Faulty defrost thermostat (heating only). Test defrost thermostat. |
-

<i>NOTICE</i>

Units with reciprocating compressors and non-bleed TXV's require a Hard Start Kit.

ASSISTANCE OR SERVICE

If you need further assistance, you can write to the below address with any questions or concerns:

Tradewinds Distributing Company, LLC
14610 Breakers Drive
Jacksonville, FL 32258

Please include a daytime phone number in your correspondence.
Or call toll free: 1-866-944-7575.

WPIO-259K

© 2010. All rights reserved.

®Registered Trademark/TM Trademark of Whirlpool, U.S.A.,
Manufactured under license by Tradewinds Distributing Company, LLC, Jacksonville, Florida.
Warranty provided by manufacturer. All other trademarks are owned by their respective companies.
COMFORT COMMITMENT is a trademark of Tradewinds Distributing Company, LLC.

9/10
Printed in U.S.A.